



## **INFORMATION FOR LIMITED DISTRIBUTION**

# Technical Bulletin

**Ref:** TB-25002-ENG

**Issue date:** 03-2025

**Product:** INOmax DS<sub>IR</sub>®, INOmax DS<sub>IR</sub>® Plus, INOflo DS

**Priority:** Low

**Affected parts:** Accessories

**Classification:** Limited Distribution

**Subject:** Discontinuation of 50418 Sensormedics 3100A/B Filtered Circuit Disposable Adapter kit  
Creation of 50457 ADAPTER, 22 mm OD X 10 mm OD (5 pack) kit

---

The purpose of this Technical Bulletin is to inform the user that the 50418 Sensormedics 3100A/B Filtered Circuit Disposable Adapter kit has been discontinued and will no longer be offered as a continued product.

The reason that the 50418 kit is being discontinued is that Sensormedics has discontinued their filtered circuit offering and the 50418 accessory kit is no longer required.

Here are the components affected by the discontinuation:

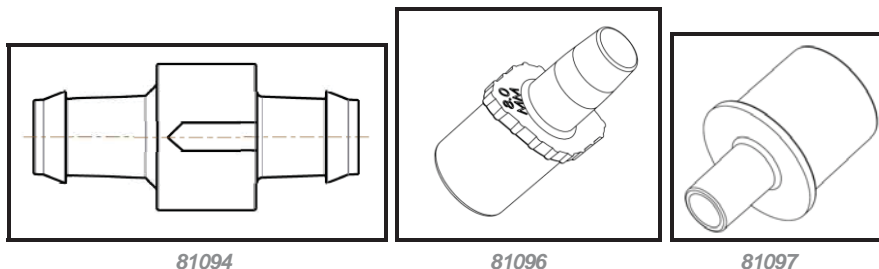

Property of

# Mallinckrodt™

## Sensormedics 3100A/B Filtered Circuit Disposable Adapters Convenience Pack

REF

LOT

Use By:





Package includes:

81094	One-Way Valve, Fits 3/8 inch Tubing	Qty. 1
81096	Adapter, 15M Fits 8.0 mm ID Tubing	Qty. 1
81097	Adapter, 22 mm OD X 10 MM OD	Qty. 1

**Warning:**

- **Omission of the one-way valve may result in high NO delivery.**

Use only the parts provided in this disposable package and tightly secure all connections.

Symbols glossary provided at [www.inomax.com](http://www.inomax.com)

 Mallinckrodt Manufacturing LLC  
6603 Femrite Drive,  
Madison, WI 53718-6801 USA

**EU Authorized Representative:**  
Medical Device Safety Service GmbH  
Schiffgraben 41, Hannover Germany

For the 81097 Adapter, 22 mm OD X 10 mm OD component, there is a continued need for use. Therefore, a new 5-piece quantity pack has been created and is listed below.

**50457 ADAPTER, 22 mm OD X 10 mm OD (5 PACK of 81097)**

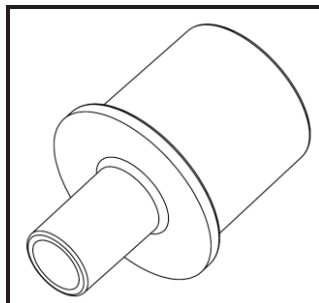

81097





Property of

# Mallinckrodt™

ADAPTER, 22mm OD X 10mm OD  
(5 Pack of 81097)

**REF**   Use By:

**LOT**

   2797  **Rx ONLY** **MD**

Symbols glossary provided at [www.inomax.com](http://www.inomax.com)

 Mallinckrodt Manufacturing LLC  
6603 Femrite Drive,  
Madison, WI 53718-6801 USA

**EU Authorized Representative:**  
Medical Device Safety Service GmbH  
Schiffgraben 41, Hannover Germany

For technical assistance regarding any of the above devices, please contact Product Support at 1-877-566-9466 (North America) or your specific country manager.

Mallinckrodt Manufacturing LLC  
6603 Femrite Drive,  
Madison, WI 53718-6801 USA

Mallinckrodt, the “M” brand mark and the Mallinckrodt Pharmaceuticals logo are trademark of a Mallinckrodt company. Other brands are trademarks of a Mallinckrodt company or their respective owner. ©2025 Mallinckrodt.

This Technical Bulletin and its contents may not be reproduced, presented, displayed, or otherwise shared, in whole or in part, with any third party without Mallinckrodt Pharmaceuticals’ prior written consent.



**Europe**

European Authorized Representative  
MDSS GmbH  
Schiffgraben 41  
30175 Hannover, Germany

